



Guidelines on the Declaration of Conformity

A conformity evaluation has been carried out for the product in terms of the EC Low Voltage Directive 2014/35/EC and the EMC Directive 2014/30/EU. The Declaration of Conformity is laid out in writing in a separate document and can be requested if required.

Guidelines on the EMC Directive (2014/30/EU)

The product cannot be operated independently according to the EMC directive. Only after integration of the product into an overall system can this be evaluated in terms of the EMC. For electronic equipment, the evaluation has been verified for the individual product in laboratory conditions, but not in the overall system.

Guidelines on the Machinery Directive (2006/42/EC)

The product is a component for installation into machines according to the machinery directive 2006/42/EC. The product can fulfil the specifications for safety-related applications in coordination with other elements. The type and scope of the required measures result from the machine risk analysis. The product then becomes a machine component and the machine manufacturer assesses the conformity of the safety device to the directive. It is forbidden to start use of the product until you have ensured that the machine accords with the regulations stated in the directive.

Guidelines on the ATEX Directive

Without a conformity evaluation, this product is not suitable for use in areas where there is a high danger of explosion. For application of this product in areas where there is a high danger of explosion, it must be classified and marked according to directive 2014/34/EU.

Safety and Guideline Signs

DANGER



Immediate and impending danger, which can lead to severe physical injuries or to death.

CAUTION



Danger of injury to personnel and damage to machines



Guidelines on important points

General Safety Guidelines

DANGER



Danger of death! Do not touch voltage-carrying lines and components.

DANGER



Danger of burns when touching hot surfaces

CAUTION



- Danger from devices caused by short-circuits and earth short-circuits at the terminals
- Electronic devices cannot be guaranteed fail-safe.

During the risk assessment required when designing the machine or system, the dangers involved must be evaluated and removed by taking appropriate protective measures.

To prevent injury or damage, only professionals and specialists are allowed to work on the devices. They must be familiar with the dimensioning, transport, installation, initial operation, maintenance and disposal according to the relevant standards and regulations.

General Safety Guidelines



Only carry out installation, maintenance and repairs in a de-energised, disengaged state and secure the system against inadvertent switch-on.



Before product installation and initial operation, please read the Installation and Operational Instructions carefully and observe the Safety Regulations. Incorrect operation can cause injury or damage.

Installation and Operational Instructions for ROBA®-switch Type 017._00.2

(B.017+002.EN)

Application

ROBA®-switch fast acting rectifiers are used to connect DC consumers to alternating voltage supplies, for example electromagnetic brakes and clutches (ROBA-stop®, ROBA®-quick, ROBATIC®) as well as electromagnets, electrovalves, etc.

Fast acting rectifier ROBA®-switch 017._00.2

- Consumer operation with overexcitation or power reduction
- Input voltage: 100 – 500 VAC
- Maximum output current I_{RMS} : 3 A at 250 VAC
- UL-approved

Function

The ROBA®-switch is used for operation at an input voltage of between 100 and 500 VAC, depending on the size. It can switch internally from bridge rectification output voltage to half-wave rectification output voltage. The bridge rectification time can be modified from 0.05 to 2 seconds by exchanging the external resistor (R_{ext}).

Electrical Connection (Terminals)

- 1 + 2 Input voltage (fitted protective varistor)
- 3 + 4 Connection for external contact for DC-side switch-off (with an installed bridge, switch-off only takes place AC-side with a longer brake engagement time)
- 5 + 6 Output voltage (fitted protective varistor)
- 7 + 8 R_{ext} for bridge rectification time adjustment



Dimensions (mm)

Type 017.000.2

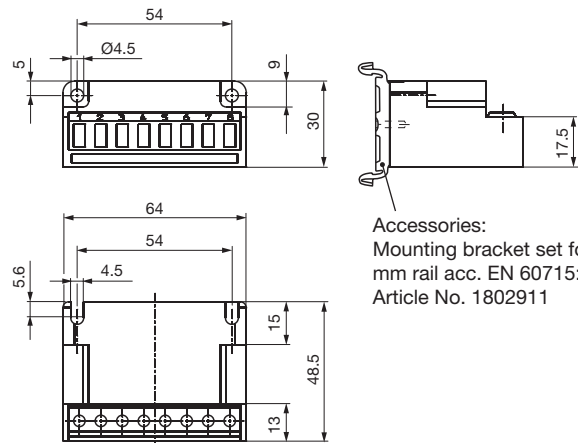

Accessories:
Mounting bracket set for 35 mm rail acc. EN 60715:
Article No. 1802911



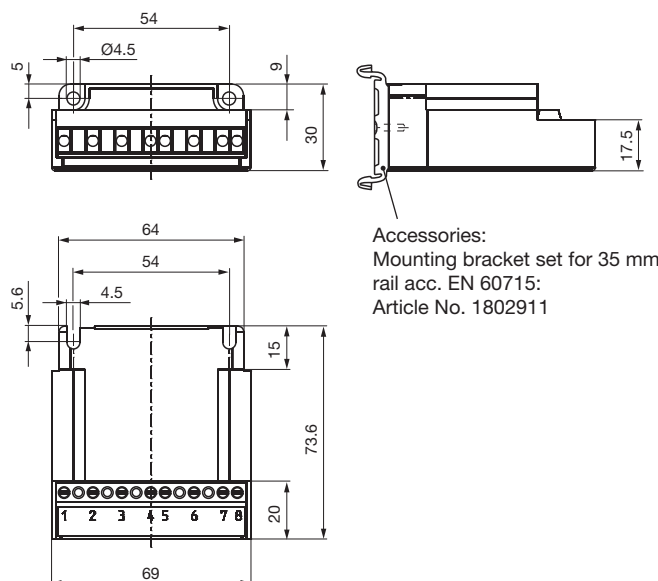





Type 017.100.2



Accessories:
Mounting bracket set for 35 mm rail acc. EN 60715:
Article No. 1802911

Installation and Operational Instructions for ROBA®-switch Type 017._00.2

(B.017+002.EN)

Technical Data				Type 017.000.2		Type 017.100.2	
				Size 10	Size 20	Size 10	Size 20
Input voltage	$\pm 10\%$ 50 / 60 Hz	U_{AC}	[VAC]	100 – 250	200 – 500	100 – 250	200 – 500
Output voltage	$(= 0.9 \times U_{AC})$	U_{bridge}	[VDC]	90 – 225	180 – 450	90 – 225	180 – 450
	$(= 0.45 \times U_{AC})$	$U_{half-wave}$	[VDC]	45 – 113	90 – 225	45 – 113	90 – 225
Output current	at $\leq 45^\circ C$	I_{RMS}	[A]	2.0	1.8	3.0	2.0
	at max. $70^\circ C$	I_{RMS}	[A]	1.0	0.9	1.5	1.0
Fitted protective varistors		U_{RMS}	[V]	275	550	275	550
Device fuses				FF 5 A (H) 5 x 20 mm	FF 4 A (H) 6.3 x 32 mm	FF 6.3 A (H) 5 x 20 mm	FF 5 A (H) 6.3 x 32 mm
Protection				IP65 components	IP20 terminals	IP10 R _{ext}	
Terminals				Nominal cross-section 1.5 mm ² (AWG 22-14), screws M3, max. tightening torque 0.5 Nm			
Ambient temperature			[°C]	-25 to +70			
Storage temperature			[°C]	-40 to +70			
Conformity markings				 	  up to 300 V	 	 
Installation conditions				The installation position can be user-defined. Please ensure sufficient heat dissipation and air convection! Do not install near to sources of intense heat!			

Wiring example

(400 VAC, AC-side switching)

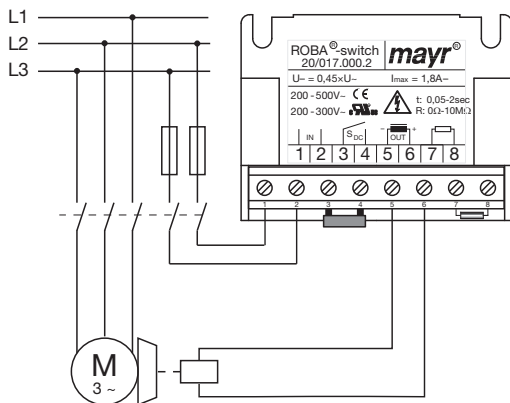

AC-side switching means **low-noise switching**; however, the brake engagement time is longer (approx. 6 – 10 times longer than with DC-side switching), use for non-critical braking times.

Wiring example

(400 VAC, DC-side switching)

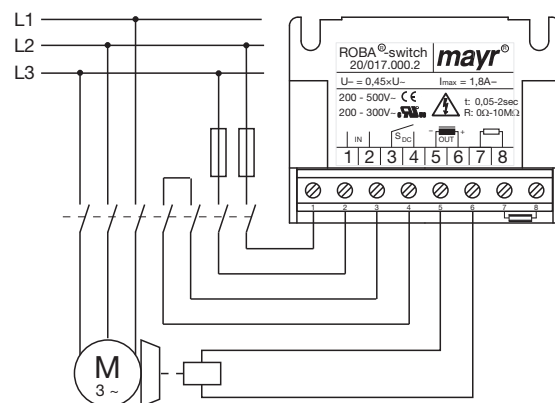

DC-side switching means **short brake engagement times (e.g. for EMERGENCY STOP operation)**; but louder switching noises will occur.

Protection circuit



When using DC-side switching, the coil must be protected by a suitable protection circuit according to VDE 0580, which is integrated in *mayr*®-rectifiers. Nevertheless, the high voltage induced on circuit interruption produces switching sparks, which lead to contact consumption.

Therefore, only use the main contacts of a contactor suitable for inductive loads with a minimum contact opening of 3 mm for switching the DC-side contact S_{DC}. Connecting the main contacts in series reduces wear.

Switch-ON

Switch-on always takes place AC-side, as only then is the overexcitation activated.

Switch-OFF



If short switching times are required, please switch DC-side. The AC-side should always be switched as well, in order to activate the overexcitation.

If a longer brake engagement time or a quieter switching noise is required, please switch AC-side. For this, a bridge must be installed between terminals 3 and 4.

Device Fuses

To protect against damage from short-circuits or earth short-circuits, please add suitable device fuses to the mains cable. As an alternative, a motor protection switch can be used. This must be adjusted to the holding current of the brake; at the same time it serves as overload protection for the brake.

Short-circuits or earth short-circuits occurring during the overexcitation time period can lead to ROBA®-switch failures. After fuse elements have reacted to a malfunction, the ROBA®-switch must be checked for functional and operational safety (overexcitation voltage, switch-off voltage, response delay time, holding voltage).

The same procedure is to be carried out after coil failure.

Overexcitation

On overexcitation, the brake is initially energised with a voltage higher than the nominal voltage. This decreases the separation time t_2 .



Increased wear (enlarged air gap) as well as coil heat-up lengthen the brake separation time t_2 . Therefore, when dimensioning the overexcitation time t_o , please select at least double the separation time t_2 on each brake Type and size (catalogue values).

Different external resistors between terminals 7 and 8 allow the adjustment of different overexcitation times. The overexcitation time has a standard adjustment of $0.45 \text{ s} \pm 20 \%$.

Overexcitation Times

Overexcitation time	External resistors on terminals 7 and 8
t_o	R_{ext}
[s]	[Ω]
0.05	0 (bridge)
0.10	22 K
0.20	82 K
0.45	221 K (standard)
0.69	390 K
0.76	470 K
0.95	680 K
1.15	1 M
1.25	1.30 M
1.53	2.20 M (included)
2.00	10 M
2.15	open

The times printed in bold can be adjusted for delivery. For the other times, please select the respective resistors.

Recovery Time 100 ms

The recovery time is the amount of time the ROBA®-switch requires in order to reach its starting position after switch-off. Therefore, the input voltage may be switched on again at the earliest after 100 ms.

During cycle operation, please take suitable measures to ensure that the recovery time of 100 ms is maintained.

Coil Capacity

The values for the **maximum coil nominal capacity** stated in the Table are guideline values for a switching frequency of maximum 1 cycle per minute and for maintenance of the permitted current I_{RMS} .

Sizes	Input voltage U_{AC} [VAC]	Coil nominal voltage U_N [VDC]	Coil nominal capacity P_N [W]				Operation with	
			Type 017.000.2		Type 017.100.2		over-excitation	power reduction
			≤ 45 °C	70 °C	≤ 45 °C	70 °C		
10	115	104	416	208	624	312		x
		104	208	104	312	156	x	
	230	180	623	312	935	437	x	x
		207	824	412	1236	618		x
20	230	104	187	94	208	104	x	
		180	561	280	623	312	x	x
		207	742	371	824	412		x
	400	180	324	162	360	180	x	
		207	428	214	476	238	x	x
		225	506	253	563	281	x	x
		500	225	405	203	450	225	x



If the switching frequency is larger than 1 cycle per minute or if the overexcitation time t_o is longer than double the separation time t_2 , please observe the following:

$$P \leq P_N$$

The coil capacity P must not be larger than P_N or the nominal current I_{RMS} which flows through the ROBA®-switch must not be exceeded, as otherwise the coil and the ROBA®-switch can fail due to thermal overload.

Time Diagram:

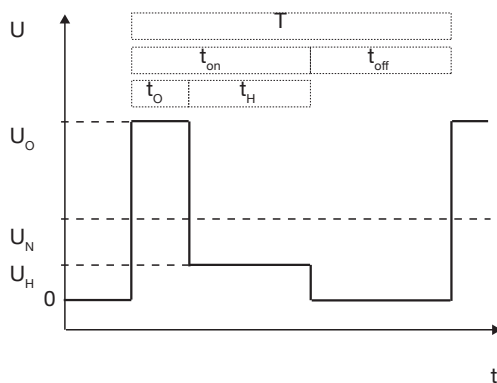

Calculations:

P [W] RMS coil capacity dependent on switching frequency, overexcitation, reduction in capacity and duty cycle

$$P = \frac{P_o \times t_o + P_H \times t_H}{T}$$

P_N [W] Coil nominal capacity (catalogue values, Type tag)

P_o [W] Coil capacity on overexcitation

$$P_o = \left(\frac{U_o}{U_N} \right)^2 \times P_N$$

P_H [W] Coil capacity at reduced capacity

$$P_H = \left(\frac{U_H}{U_N} \right)^2 \times P_N$$

t_o [s] Overexcitation time

t_H [s] Time of operation with reduction in capacity

t_{off} [s] Time without voltage

t_{on} [s] Time with voltage

T [s] Total time ($t_o + t_H + t_{off}$)

U_o [V] Overexcitation voltage (bridge voltage)

U_H [V] Holding voltage (half-wave voltage)

U_N [V] Coil nominal voltage

I_{eff} [A] RMS current dependent on switching frequency, overexcitation time and duty cycle

$$I_{RMS} = \sqrt{\frac{P \times P_N}{U_N^2}}$$

EMC-compatible Installation

The ROBA®-switch does not produce any interference. However, if the device is used in connection with other components (e.g. electromagnetic brakes), the resulting interference can exceed the permitted limit values. Please therefore install the rectifier in accordance with the EMC directives!

The measure described for compliance with the EMC directive is examined under laboratory conditions, and cannot necessarily be bindingly transferred onto the condition of a machine or equipment in case of deviations. The inspection tests the individual components *mayr*®-ROBA®-switch and the *mayr*®-brake and is applicable for an input voltage of up to 500 VAC.

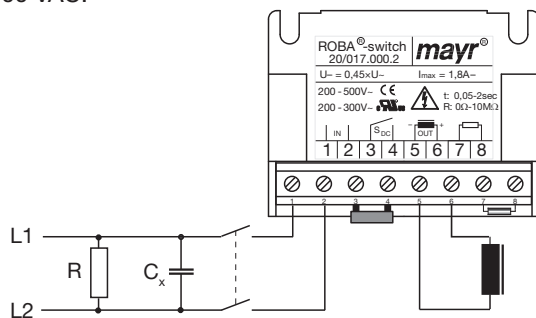

Measure

Installation of a C_x -capacitor into the AC connection:

$C_x = 330 \text{ nF} / 660 \text{ V}$ The voltage resistance of the capacitor must be at least that of the U_{AC} mains voltage!

$R = 0.5 \text{ M}\Omega$ discharge resistor

The C_x -capacitor must be mounted in front of the AC switching contacts!



- Avoid an antennae effect: Keep the supply cables as short as possible; do not form rings or loops with the cables!
- Mount good earth connections onto the metal body of the brake!
- Lay control cables separately from power cables or from strongly pulsating supply cables!

Standards

Product standard

VDE 0160/DIN EN 50178:1998-04

Electronic equipment for use in power installations

EMC inspections

EN 61000-6-2:2006-03

Interference immunity

EN 61000-6-4:2007-09

Interference emission

Insulation coordination

acc. VDE 0110 / EN 60664:2008-01

Overvoltage category III

Pollution degree 2 for Type 017.000.2

Pollution degree 3 for Type 017.100.2

Rated insulation voltage 500 V_{RMS}

Intended Use

mayr®-rectifiers have been developed, manufactured and tested as electronic equipment in compliance with the DIN EN 50178 standard and in accordance with the EU Low Voltage Directive. During installation, operation and maintenance of the product, the requirements for the standard must be observed. *mayr*®-rectifiers are for use in machines, systems and devices and must only be used in the situations for which they are ordered and confirmed. The products are designed for installation into electrical control cabinets and terminal boxes. Using them for any other purpose is not allowed.